

WOOD FIREPLACE

COLLECTION



Valcourt



Information in this brochure is for reference only. Some changes may have been made to the products or technical data after the publication of this brochure. Valcourt reserves the right to modify its products without any obligation on its part.



FOR AMBIANCE	6
FP1LM - MANOIR	8
FP2S06 FP2D06 - BEAUMONT	10
FP5SBO - WESTMOUNT	12
FP7CB - ANTOINETTE	14
FP11 - FRONTENAC	16
FP16 - ST-LAURENT	18
FOR PERFORMANCE	22
FP10R - LAFAYETTE II	24
FP10RS - LAFAYETTE II - SQUARE	26
FP12R - MUNDO II	28
FP15 - WATERLOO	30
FP15A - WATERLOO - ARCHED	32
TECHNICAL DATA	34
MANUFACTURERS, BRANDS AND TYPES OF APPROVED CHIMNEYS	46
HEAT DISTRIBUTION SYSTEMS	48
HEATING CALCULATOR	50
WARRANTY	52
FIREPLACE ACCESSORIES	54



OUR STORY

A tradition of excellence, for more than 60 years.

It all started in 1958, when brothers Auguste and Lucien Valcourt founded the company Valcourt et Frère Enr. Very talented, they first stood out in the manufacture of stairs and wrought iron balconies that adorned the most beautiful homes of Quebec. Guided by his creativity, Auguste began in 1975 the manufacture of custom fireplace doors and slowly relinquished stairs and balconies. Once again, the quality of the products offered allowed the company to stand out in this new adventure.

It was in 1992 that Valcourt discovered its true vocation and manufactured its first wood fireplace: the Manoir. Just as popular with consumers as with industry experts, this model has been replicated by multiple manufacturers without ever being matched. A few years later, Valcourt innovated again with its legendary guillotine fireplace, called Antoinette. Very first guillotine fireplace on the market, this model is the pioneer of this type and was a major success. Over the years, the fireplace industry has undergone many changes in environmental standards that have imposed increasingly severe restrictions. Living up to its previous successes, Valcourt has brilliantly met these new challenges and launched in 2015 the largest fireplace on the market that meets the EPA requirements.

Guided by endless creativity and the desire to offer the best to its customers, Valcourt continues this tradition of excellence and presents in 2020 a whole new range of gas fireplaces.

Fire, by Valcourt.

A person wearing a patterned poncho stands on a wooden railing, looking out over a snowy landscape. The scene is misty and overcast, with snow-covered evergreen trees in the foreground and a body of water in the distance. The overall atmosphere is serene and wintry.

Decorative fireplaces

for ambiance



The main purpose of these fireplaces is the ambiance and comfort of a wood fire, with doors opened or closed. If needed, they are also an alternate source of heat.

MANOIR

FPILM

The Manoir is the updated version of Valcourt's very first fireplace. The steel framed double doors and ceramic glass are second to none; they slide effortlessly and without special tools into each side of the fireplace, allowing for an exceptional view of the crackling flames.

This fireplace will allow you to be creative when designing your decor thanks to its faceplate options available in different finishes. In addition, you will benefit from the maximum heat of the Manoir thanks to its included fan and the heat distribution options (forced air or gravity).

This model is
EPA QUALIFIED
 Under the LOW MASS
 Wood-Burning Fireplace Program
PHASE 2
 EMISSION
 LEVEL

Faceplate –
modern



VAIFE05

Faceplate –
traditional



VAIFE06

Hot air gravity kit –
traditional

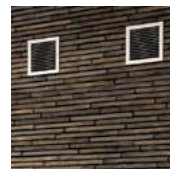

AC01375

Hot air gravity kit –
modern



AC01376



— BEAUMONT

FP2S06
FP2D06

Imagine sitting on your couch or even lounging in your bath, sipping your favorite drink watching the fire dance and crackle in your Beaumont fireplace. What a nice way to get rid of the stress of the day!

Ultimate decorative fireplace, the Beaumont offers two configurations of double doors, retractable (FP2S06) or folding (FP2D06), as well as 3 faceplate options to style your fireplace.

This appliance is
**EPA
exempt**

Black narrow
overlap



VA2FE06

Brushed nickel
narrow overlap



VA2FE39

Black large
overlap



VA2FL06



— WESTMOUNT

FP5SBO

What could be better than having a Valcourt fireplace in a room? To have one in two rooms at a time! Elegant, this double-sided wood fireplace offers 3 faceplate options to frame the flames to perfection. Very romantic between the master bedroom and the bathroom. Perfect between the living room and the dining room and, why not, between the dining room and the kitchen.

Versatile, the Westmount fireplace adapts to any room and will create a cozy atmosphere wherever you want.

This appliance is
EPA
exempt

Black narrow
overlap



VA2FE06

Brushed nickel
narrow overlap



VA2FE39

Black large
overlap



VA2FL06



Decorative fireplaces

— ANTOINETTE

FP7CB

A true delight for lovers of pure lines with its large glass surface and its sleek faceplate, the Antoinette fireplace will enhance any decor while respecting the style of your room. The authentic guillotine door, developed by Valcourt, slides effortlessly to allow you to easily feed the fire, just like its fire screen also equipped with a guillotine mechanism.

The Antoinette qualifies for phase II of the EPA's voluntary program which aims to reduce wood fireplaces emissions, making it up to 70% cleaner than unqualified models!

This model is
EPA QUALIFIED
 Under the LOW MASS
 Wood-Burning Fireplace Program

PHASE 2
 EMISSION
 LEVEL

Masonry trim



VA7TR

Narrow overlap

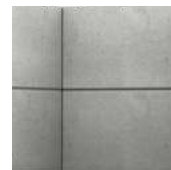

VA7FE06

Moulded refractory
brick panels –
contemporary

VA7071M

Moulded refractory
brick panels –
classic

VA7071BR



Decorative fireplaces

— FRONTENAC

FP11

Dare to imagine the most impressive fireplace, respectful of the environment! Exceptionally large, the Frontenac is not only a noble hotel located in the heart of Quebec City; it is also the largest fireplace of the Valcourt line. This sumptuous model has a guillotine glass door and fire screen that simply disappear under the hearth, to easily feed the fire and enjoy the view of the flames.

Using advanced technology to reduce particulate emissions, the FP11 qualifies for Phase II of the EPA's voluntary program; 70% cleaner than non-qualified decorative wood fireplaces, the Frontenac will bring elegance, without compromising on air quality.

This model is **EPA QUALIFIED** Under the LOW MASS Wood-Burning Fireplace Program **PHASE 2** EMISSION LEVEL

Masonry trim – arched

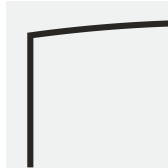

VAl1TA

Masonry trim – straight

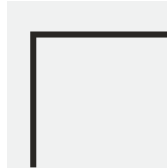

VAl1TR

Narrow overlap – arched



VAl1FA06

Narrow overlap – straight



VAl1FE06

Moulded vermiculite panels – Herringbone

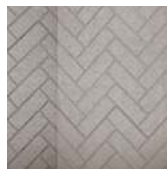

VAl1071H

Moulded brick panels – contemporary

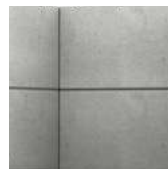

VAl1071M

Moulded brick panels – classic



VAl1071BR



— ST-LAURENT

FP16

This remarkably proportioned wood fireplace will become the centerpiece of your home. Its perfect rectangle gives it a sober and modern look, and still provides a warm ambiance to the room. Understated yet large, it leaves plenty of room for the beauty of the flames.

Its glass guillotine door slides effortlessly and provides plenty of space for loading wood. The fire screen, also fitted with a guillotine mechanism, allows you to safely enjoy the warmth of an open fire.

This appliance is
EPA
exempt

Masonry trim



VA16TR

Narrow overlap



VA16FE06

Moulded brick panels – contemporary

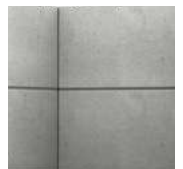

VA1607IM



Decorative fireplaces



MADE BY CANADIANS, FOR CANADIANS.

Proudly established in Quebec since 1991, Valcourt is a local business for which fireplaces are a true vocation.

Choosing a Valcourt product means prioritizing the quality of the finish and materials, the manufacturing robustness and the durability stemming from undeniable know-how. By becoming a Valcourt customer, you will benefit from local after-sales support that meets your expectations, provided by a network of expert retailers, in collaboration with our experienced team.

Choosing a Valcourt product contributes to the influence of the local economy by supporting our communities and the people who work under fair conditions. As a Canadian manufacturer, it is also important for us to use quality raw materials by sourcing from local partners. More than 90% of our raw materials come from North America, notably steel.

High-efficiency wood fireplaces

for performance

The background is a dark, moody scene, possibly a night sky or a forest at night, with a white vertical bar on the left side. The text is centered in the lower half of the image.

The main purpose of these fireplaces is eco-friendly heating with emissions below the limits imposed by EPA and the benefits of an efficient overnight burn. If needed, they can be used for ambiance with the doors open.

— LAFAYETTE II

FP10R

Like the great French general, the Valcourt team has been able to use its tactical skills to upgrade this non-catalytic unit, so that it perfectly combines the new heating technology with all its elegance.

Customize your fireplace: five faceplate louvers as well as black or brushed nickel door overlays are available to enhance your decor. In addition to offering a distinctive look, the appliance follows the most restrictive EPA regulations, making it the fireplace of choice for those who want to use wood as a renewable and clean source of heat.



Door overlay – black



VA10RE07

Door overlay – brushed nickel



VA10RE40

Faceplate louver – crown



VA10L05

Faceplate louver – classic



VA10L01

Faceplate louver – arabesque



VA10L02

Faceplate louver – urban



VA10L03

Faceplate louver – mission



VA10L04



LAFAYETTE II SQUARE

FPIORS

Like the great French general, the Valcourt team has been able to use its tactical skills to upgrade this non-catalytic unit, so that it perfectly combines the new heating technology with all its elegance.

Customize your fireplace: five faceplate louvers as well as black or brushed nickel door overlays are available to enhance your decor. In addition to offering a distinctive look, the appliance follows the most restrictive EPA regulations, making it the fireplace of choice for those who want to use wood as a renewable and clean source of heat.



Door overlay – black



VA10RES07

Door overlay – brushed nickel



VA10RES40

Faceplate louver – crown



VA10LS05

Faceplate louver – classic



VA10LS01

Faceplate louver – arabesque



VA10LS02

Faceplate louver – urban



VA10LS03

Faceplate louver – mission



VA10LS04



High-efficiency fireplaces

MUNDO II

FP12R

With its sleek lines and refined look, the Mundo II completely redefines the true nature of wood heating. Its modern design perfectly combines functionality, comfort and safety. Environmentally-friendly, this non-catalytic fireplace is EPA certified with an incredibly low particle emissions rate.

The hot air gravity kit available with the Mundo II will allow you to harness all the power from this incredible fireplace while respecting the contemporary lines of your decor. The most serious user can also install a forced air kit which will allow for better and more efficient heat transfers to rooms located further from the fireplace.

EPA

Hot air gravity kit –
traditional

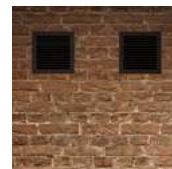

AC01375K

Hot air gravity kit –
modern



AC01389K



— WATERLOO

FP15

This striking wood fireplace is a logical and eco-friendly option for any homeowner looking to combine style and high efficiency. Its crowned facade will make it the king of your residence!

Behind its large glass doors, the combustion chamber can contain an impressive quantity of logs to heat large spaces and burn for hours, and this with the greatest respect for environmental standards.

EPA

Moulded brick panels – classic



AC02360

Faceplate – crown



VA15FL06



High-efficiency fireplaces

— WATERLOO ARCHED

FP15A

This striking wood fireplace is a logical and eco-friendly option for any homeowner looking to combine style and high efficiency. Its crowned facade will make it the king of your residence!

Behind its large glass doors, the combustion chamber can contain an impressive quantity of logs to heat large spaces and burn for hours, and this with the greatest respect for environmental standards.

EPA

Moulded brick panels – classic



AC02360

Faceplate louver – urban



VA15L03

Faceplate louver – mission



VA15L04

Faceplate louver – classic



VA15L01

Faceplate louver – arabesque



VA15L02



High-efficiency fireplaces



Technical Data



All the information you need to make an informed choice on the appliance that suits your needs. Discover the performance and general specifications of Valcourt fireplaces.

FP1LM

FP2S06 FP2D06

COLOR	Black	Black
COMBUSTION TECHNOLOGY	Non catalytic	Non catalytic
FIREBOX VOLUME (EXCLUDING GRATE OR ANDIRONS)	4.25 ft ³	3 ft ³
DOOR TYPE	Double retractable, with steel frame	Double, with steel frame
GLASS TYPE	Ceramic glass	Ceramic glass
MAXIMUM LOG LENGTH	20"	16"
LOG POSITIONING	East / West	East / West
MINIMUM CHIMNEY HEIGHT (FROM FLOOR)	15'	15'
FRESH AIR INTAKE ADAPTER (DIAMETER)	Yes (4")	Yes (4")
TEST STANDARD – SAFETY	ULC-S610 / UL127	ULC-S610 / UL127
TEST STANDARD – EMISSIONS	ASTM 2515 / ASTM 2558	EPA Exempt
EPA VOLUNTARY PROGRAM – EMISSIONS (ASTM 2515 / ASTM 2558)	2.9 g/kg	S. O.
CLEARANCES TO COMBUSTIBLE MATERIALS		
COMBUSTIBLE SHELF (FROM THE BASE OF THE FIREPLACE)	48"	46"
SIDE MANTLE ⁽¹⁾	8"	0"
SIDE WALL ⁽²⁾	24"	24"
WEIGHT	236 kg (520 lb)	191 kg (421 lb)
WARRANTY	Lifetime limited	Lifetime limited
REQUIRED ACCESSORIES	Faceplate – ① Traditional Modern ② ③	Black narrow overlap Brushed nickel narrow overlap Black large overlap
OPTIONS	Hot air gravity kit - traditional modern Forced air kit	Hot air gravity kit - traditional modern Forced air kit

FP5SBO

Black
 Non catalytic
 3.5 ft³
 Double,
 with steel frame
 Ceramic glass
 18"
 East / West
 15'
 Yes (4")
 ULC-S610 / UL127
 EPA Exempt
 S. O.

FP7CB

Black
 Non catalytic
 5.3 ft³
 Guillotine,
 with steel frame
 Ceramic glass
 18"
 East / West
 15'
 Yes (4")
 ULC-S610 / UL127
 ASTM 2515 / ASTM 2558
 4.2 g/kg

FP11

Black
 Non catalytic
 9.4 ft³
 Guillotine,
 with steel frame
 Ceramic glass
 30"
 East / West
 18'
 Yes (4")
 ULC-S610 / UL127
 ASTM 2515 / ASTM 2558
 4.2 g/kg

FP16

Black
 Non catalytic
 6.4 ft³
 Guillotine,
 with steel frame
 Ceramic glass
 30"
 East / West
 15'
 Yes (4")
 ULC-S610 / UL127
 EPA Exempt
 S. O.

46"
 0"
 24"
 232 kg (511 lb)
 Lifetime limited

Black narrow overlap
Brushed nickel narrow overlap
Black large overlap

46"
 8"
 20"
 238 kg (523 lb)
 Lifetime limited

Narrow overlap

Masonry trim

Moulded brick panels –
 Contemporary
 Classic

52"
 8"
 20"
 417 kg (920 lb)*
 Lifetime limited

Narrow overlap –
 Straight
 Arched

Masonry trim –
 Straight
 Arched

Moulded brick panels –
 Contemporary
 Classic

Moulded vermiculite panels –
 Herringbone

48"
 8 1/2"
 24"
 347 kg (765 lb)
 Lifetime limited

Black narrow overlap

Masonry trim

Moulded brick panels –
 Contemporary

Hot air gravity kit -
 traditional | modern
Forced air kit

⁽¹⁾ Subject to a maximum protrusion - see owner's manual.

⁽²⁾ From door opening.

*Without refractory bricks.

Technical data contained in this catalogue are for reference only. Any installation must be done according to the data and drawings detailed in the owner's manual.

COLOR	Black
COMBUSTION TECHNOLOGY	Non catalytic
MAXIMUM RECOMMENDED AREA	750 – 2,200 ft ²
OVERALL HEAT OUTPUT RATE (MIN. TO MAX.)	14,200 to 48,200 BTU/h
MAXIMUM HEAT OUTPUT (DRY CORDWOOD)	80,000 BTU/h
MAXIMUM BURN TIME ⁽¹⁾	8 hours
AVERAGE PARTICULATE EMISSIONS RATE	1.14 g/h
OPTIMUM EFFICIENCY	74 %
FIREBOX VOLUME (EXCLUDING GRATE OR ANDIRONS)	2,5 ft ³
DOOR TYPE	Single, with steel frame
GLASS TYPE	Ceramic glass
MAXIMUM LOG LENGTH	20"
LOG POSITIONING	East / West
MINIMUM CHIMNEY HEIGHT (FROM FLOOR)	15'
FRESH AIR INTAKE ADAPTER (DIAMETER)	Yes (4")
TEST STANDARD – SAFETY	ULC-S610 / UL127
TEST STANDARD – EMISSIONS	EPA
CLEARANCES TO COMBUSTIBLE MATERIALS	
COMBUSTIBLE SHELF (FROM THE BASE OF THE FIREPLACE)	58"
SIDE MANTLE ⁽²⁾	8"
SIDE WALL ⁽³⁾	13"
WEIGHT	225 kg (495 lb)
WARRANTY	Lifetime limited
REQUIRED ACCESSORIES	<p>Black arched faceplate</p> <p>Faceplate louver –</p> <p>① Crown Classic Arabesque Urban Mission</p> <p>② Door overlay – Black Brushed nickel</p> <p>③</p> <p>④</p>
OPTIONS	<p>Firescreen door</p> <p>Hot air gravity kit - traditional modern</p> <p>Forced air kit</p>

FP10RS

Black
 Non catalytic
 750 – 2,200 ft²
 14,200 to 48,200 BTU/h
 80,000 BTU/h
 8 hours
 1.14 g/h
 74 %
 2,5 ft³
 Single, with steel frame
 Ceramic glass
 20"
 East / West
 15'
 Yes (4")
 ULC-S610 / UL127
 EPA

FP12R

Black
 Non catalytic
 750 – 2,200 ft²
 14,200 to 48,200 BTU/h
 80,000 BTU/h
 8 hours
 1.14 g/h
 74 %
 2,5 ft³
 Single, with steel frame
 Ceramic glass
 20"
 East / West
 15'
 Yes (4")
 ULC-S610 / UL127
 EPA

FP15

Black
 Non catalytic
 1 000 – 2,800 ft²
 16,610 to 43,021 BTU/h
 95,000 BTU/h
 11 hours
 1.6 g/h
 69,7 %
 4,28 ft³
 Double, with cast iron frame
 Ceramic glass
 25"
 East / West
 15'
 Yes (5")
 ULC-S610 / UL127
 EPA

FP15A

Black
 Non catalytic
 1 000 – 2,800 ft²
 16,610 to 43,021 BTU/h
 95,000 BTU/h
 11 hours
 1.6 g/h
 69,7 %
 4,28 ft³
 Double, with cast iron frame
 Ceramic glass
 25"
 East / West
 15'
 Yes (5")
 ULC-S610 / UL127
 EPA

58"
 8"
 13"
 225 kg (495 lb)
 Lifetime limited

Black square faceplate

Faceplate louver –

Crown
 Classic
 Arabesque
 Urban
 Mission

Door overlay –

Black
 Brushed nickel

48"
 8"
 13"
 194 kg (427 lb)
 Lifetime limited

Hot air gravity kit -

traditional | modern

Firescreen door

Hot air gravity kit -
 traditional | modern

Forced air kit

S.O.
 8"
 24"
 247 kg (545 lb)
 Lifetime limited

Faceplate –

Crown

Moulded brick panels –

classic

Forced air kit

Warm air circulation grille –
 Modern

S.O.
 8"
 24"
 247 kg (545 lb)
 Lifetime limited

Faceplate arched black

Faceplate louver –

Classic
 Arabesque
 Urban
 Mission

Moulded brick panels –

classic

Forced air kit

Warm air circulation grille –
 Modern

⁽¹⁾ Approximate burn time and maximum recommended area may vary subject to location in home, chimney draft, chimney diameter, locality, heat loss factors, climate, fuels and other variables.

⁽²⁾ Subject to a maximum protrusion - see owner's manual ⁽³⁾ From door opening.

Technical data contained in this catalogue are for reference only. Any installation must be done according to the data and drawings detailed in the owner's manual.

FPILM – MANOIR

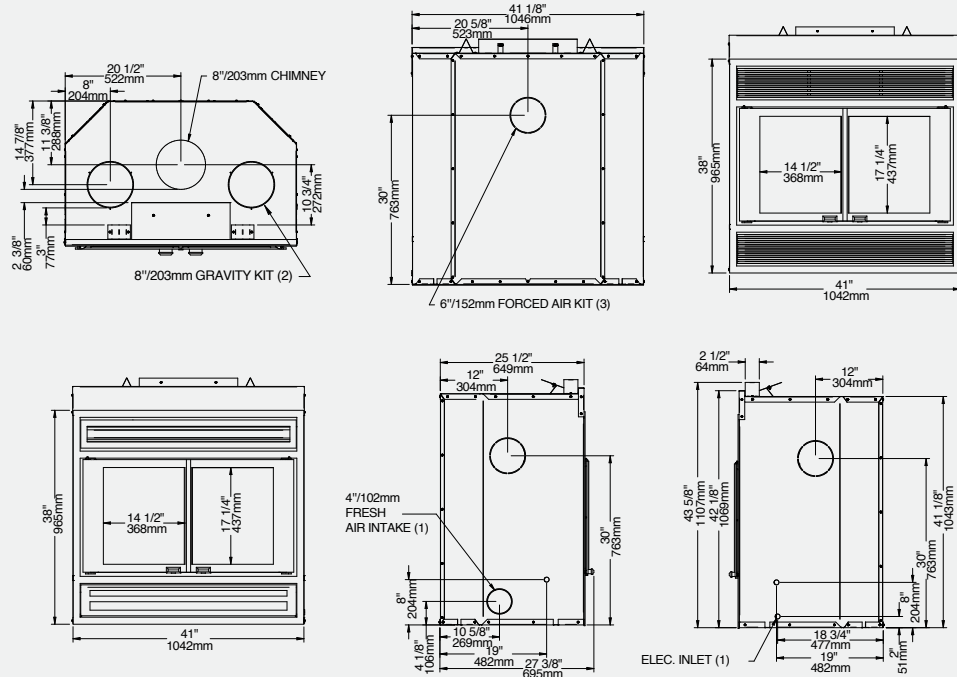

FP2S06 | FP2D06 – BEAUMONT

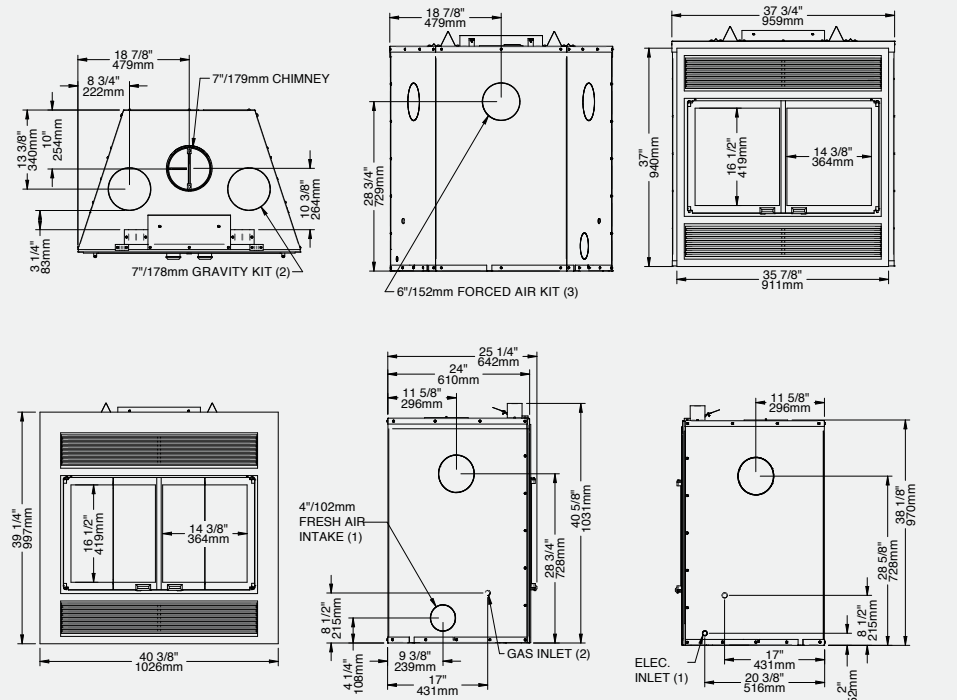

FP5SBO – WESTMOUNT

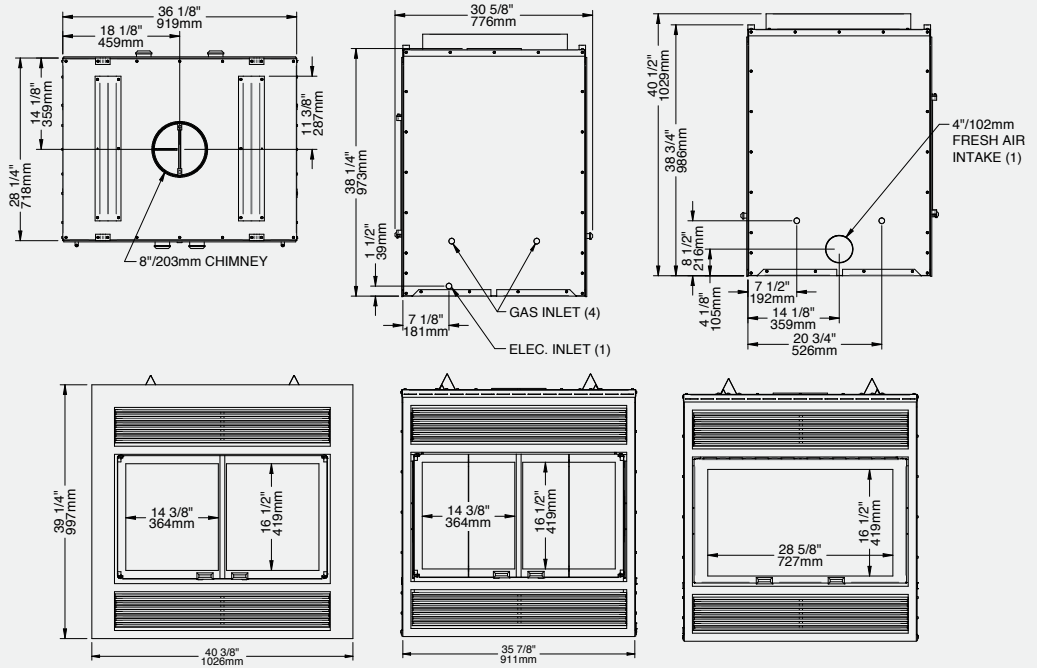

FP7CB – ANTOINETTE

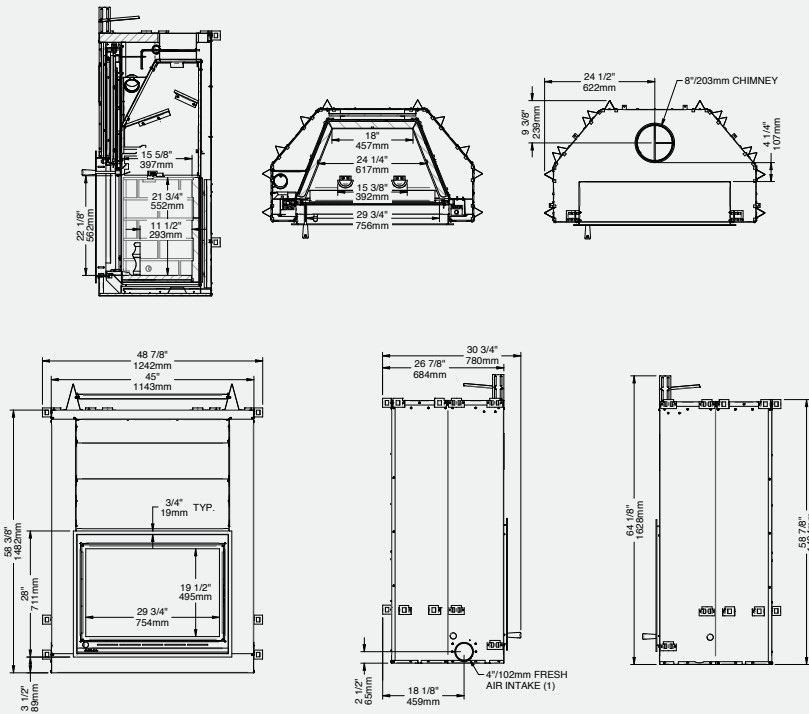

FP11 – FRONTENAC

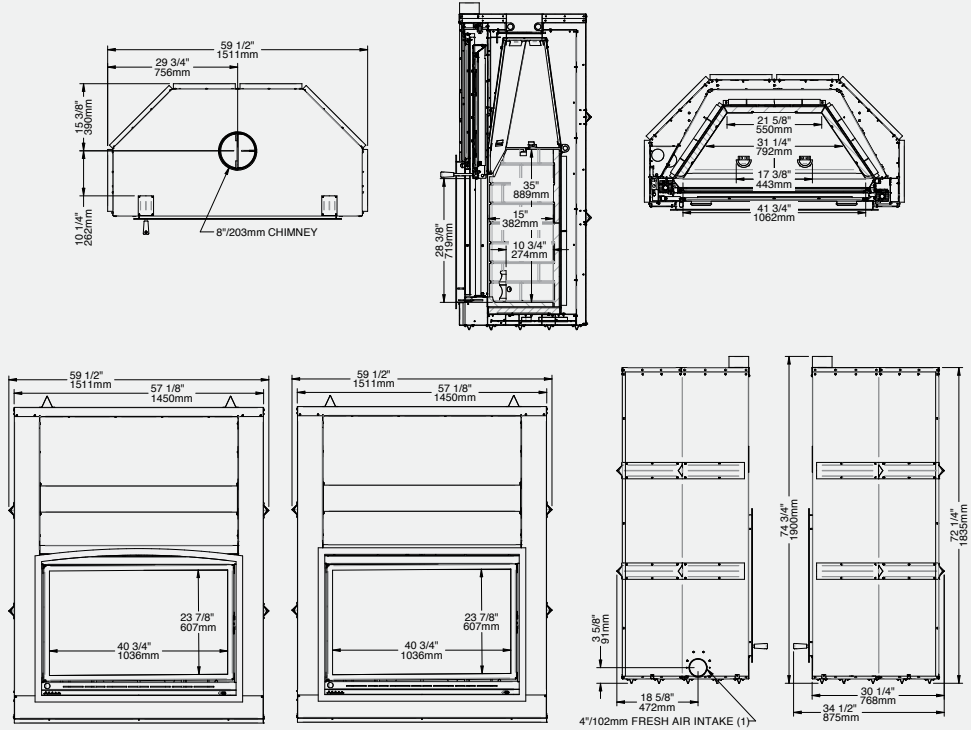

FP16 – ST-LAURENT

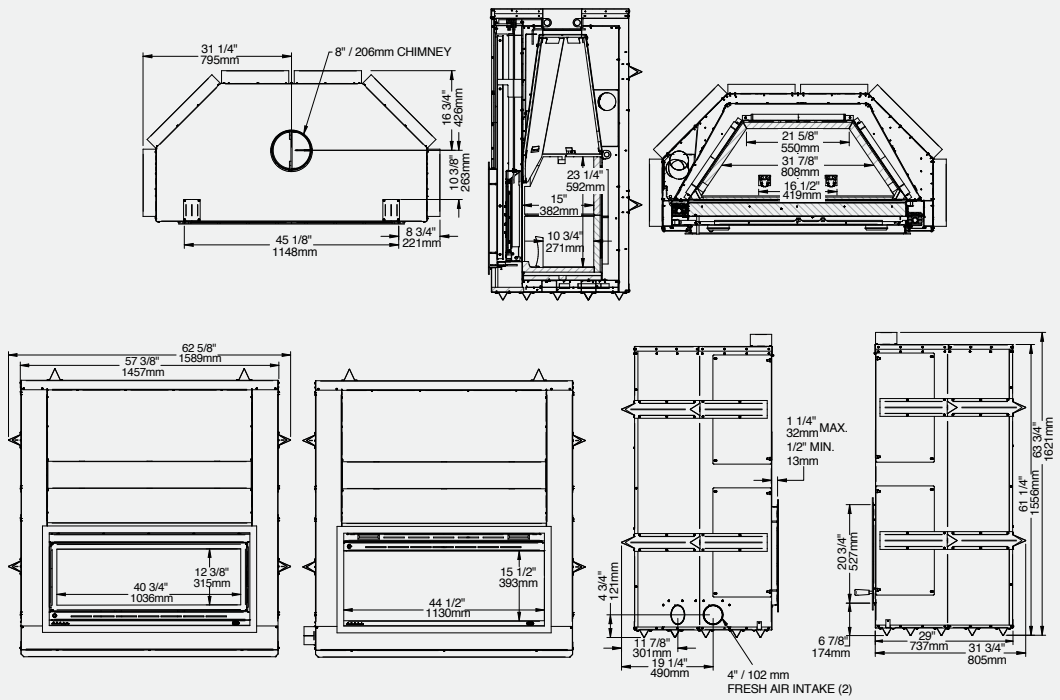

FPIOR – LAFAYETTE II

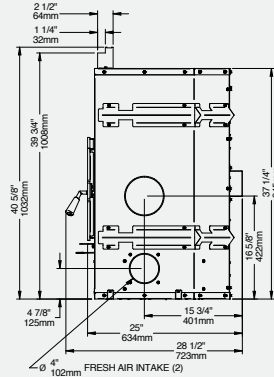
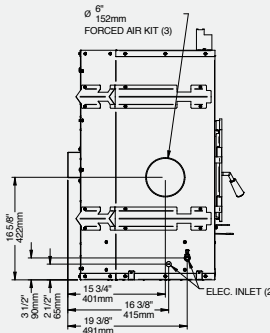
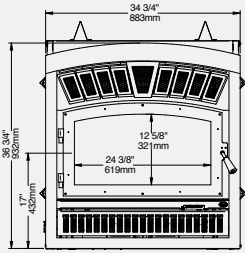
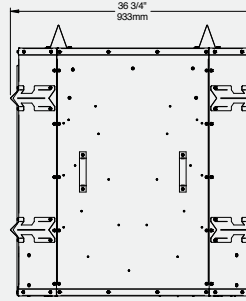
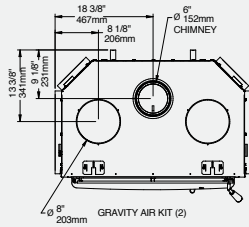

FPIORS – LAFAYETTE II – SQUARE

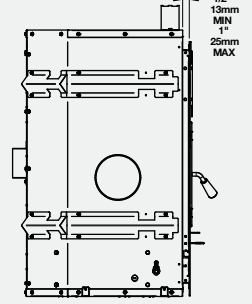
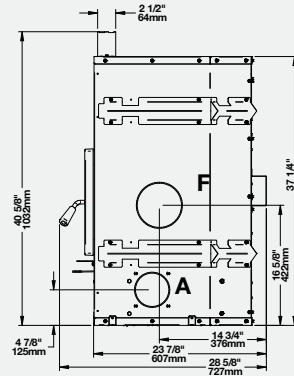
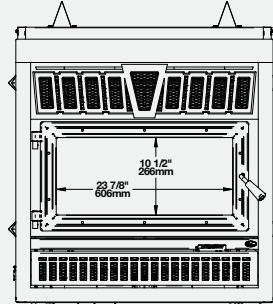
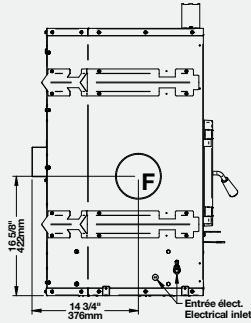
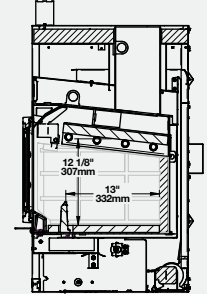
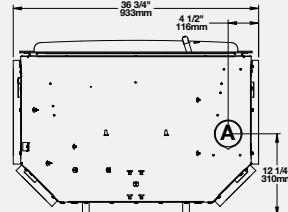
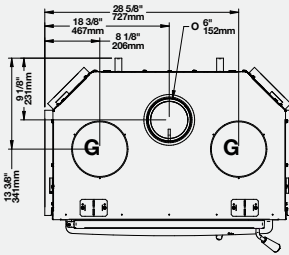
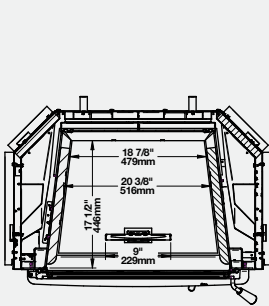

FP12R – MUNDO II

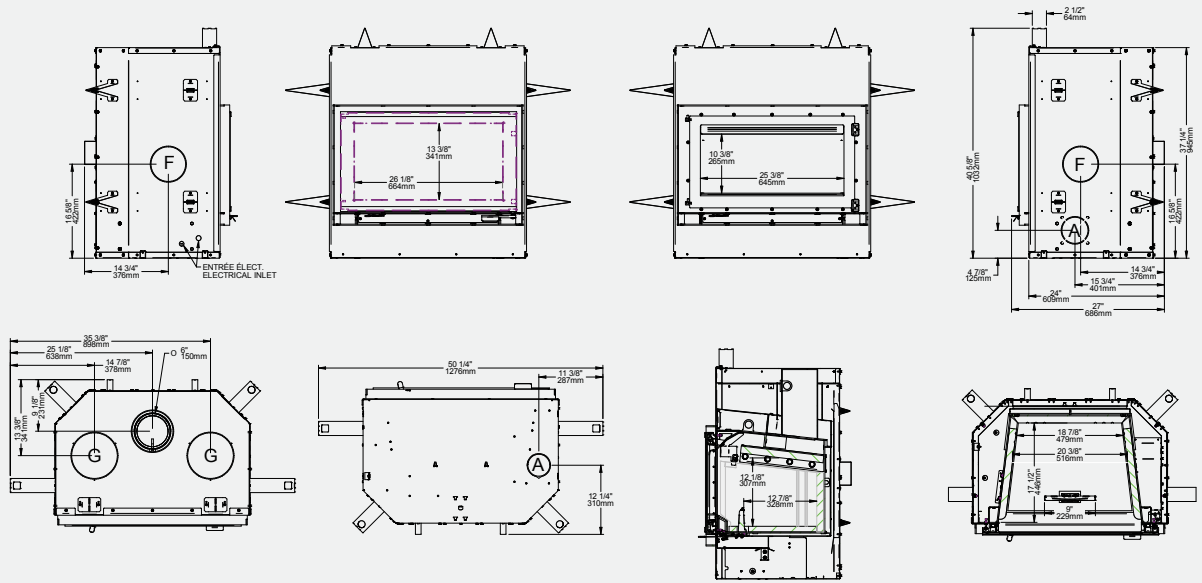

FP15 – WATERLOO

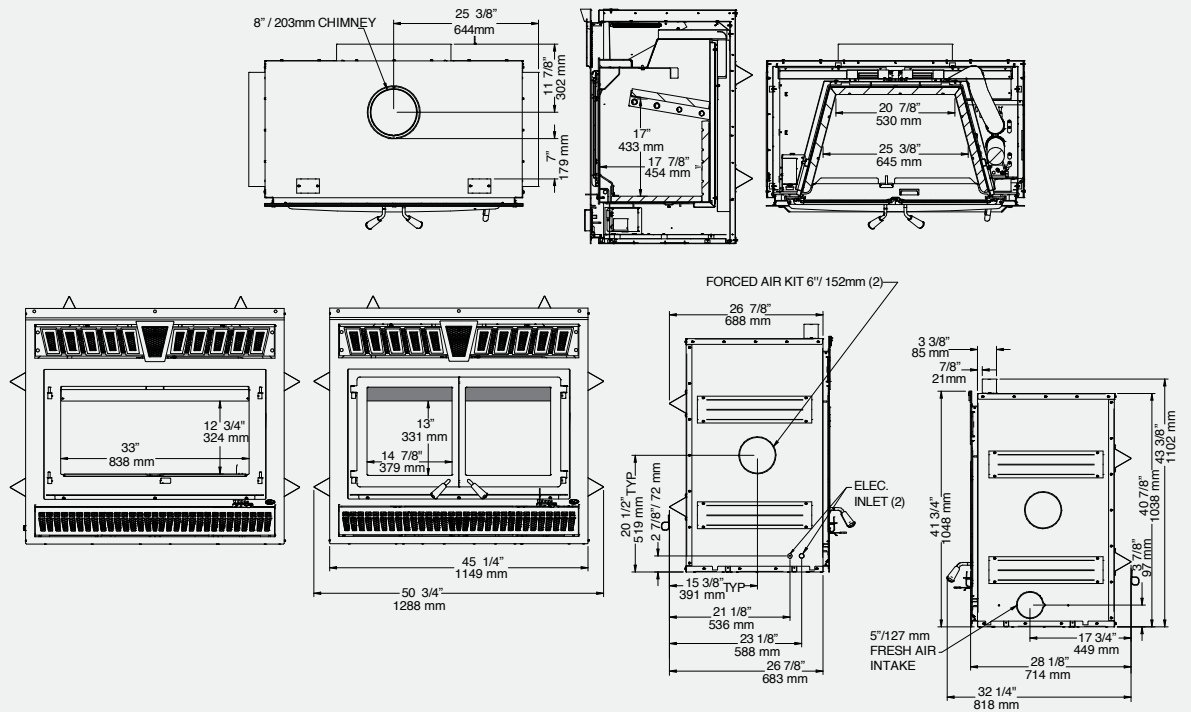

FP15A – WATERLOO – ARCHED

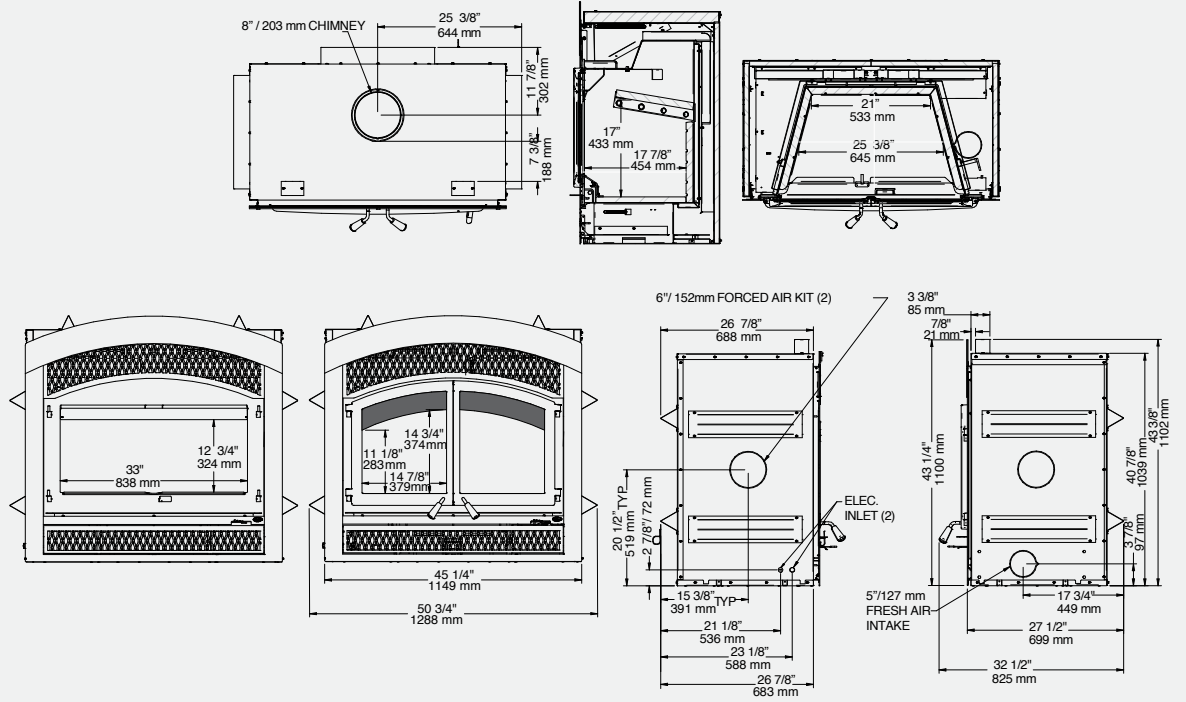

MANUFACTURERS, BRANDS AND TYPES OF APPROVED CHIMNEYS

MANUFACTURERS*	BRANDS	TYPE	FP1LM	FP2S06 FP2D06	FP5SBO
Olympia Chimney / SBI Venting Division	Ventis	1" Solid Pack	●	●	●
SBI Venting Division	Nexvent	1" Solid Pack	●	●	●
Olympia Chimney	Champion Chimney System	1" Solid Pack	●	●	●
American Metal	HSS	AC Triple Wall	●	●	●
American Metal	HS	AC Triple Wall	●	●	●
ICC	Excel 2100	1" Solid Pack	●	●	●
DuraVent	DuraTech	1" Solid Pack	●	●	●
DuraVent	DuraTech Canada (DTC)	1" Solid Pack	●	●	●
DuraVent	DuraPlus HTC	2" Solid Pack	●	●	●
DuraVent	DuraPlus	AC Triple Wall	●	●	●
DuraVent	DuraTech Premium	2" Solid Pack	●	●	●
Metal Fab	Temp Guard	1" Solid Pack	●	●	●
Security Chimney	ASHT+	1" Solid Pack	●	●	●
Security Chimney	S-2100 +	2" Solid Pack	●	●	●
Selkirk	UltimateOne	1" Solid Pack		●	●
Selkirk	Ultra-Temp (UT)	1" Solid Pack		●	●
Selkirk	Super Pro (SPR)	1" Solid Pack		●	●
Selkirk	Super Vent (JSC)	1" Solid Pack		●	●
Selkirk	Hart & Cooley (TLC)	1" Solid Pack		●	●
Selkirk	Sure-Temp (ST)	1" Solid Pack		●	●
Selkirk	Super Vent 2100 (JM)	2" Solid Pack	●	●	●
Selkirk	CF Sentinel (CF)	2" Solid Pack	●	●	●
Selkirk	Super Pro 2100 (ALT)	2" Solid Pack	●	●	●

FP7CB	FP11	FP16	FP10R	FP10RS	FP12R	FP15	FP15A
•	•	•	•	•	•	•	•
•	•	•	•	•	•	•	•
•	•	•	•	•	•	•	•
•	•	•	•	•	•	•	•
•	•	•	•	•	•	•	•
•	•						
•	•	•	•	•	•	•	•
•	•	•	•	•	•	•	•
•	•	•	•	•	•	•	•
•	•	•	•	•	•	•	•
•	•	•	•	•	•	•	•
•	•	•	•	•	•	•	•
•	•	•	•	•	•	•	•
•	•						
•	•	•	•	•	•	•	•
•	•						
•	•						
•	•						
•	•						
•	•						
•	•						
•	•	•	•	•	•	•	•
•	•	•	•	•	•	•	•
•	•	•	•	•	•	•	•

*Specific components may be required depending on the chimney manufacturer.
Technical data contained in this brochure is for reference only. Any installation must be done according to the data and drawings detailed in the owner's manual.

HEAT DISTRIBUTION SYSTEMS

Forced air kit

This system allows you to manage the heat distribution automatically. Using a wall thermostat, you can select the temperature you want to maintain in the room where the fireplace is located. Once the thermostat has reached the desired temperature, the excess heat is redirected to another room up to 50 feet (15 m) away from the fireplace using a 300 CFM blower. That way, you can enjoy a nice fire in your living room without the discomfort of excess heat generated by your Valcourt fireplace.

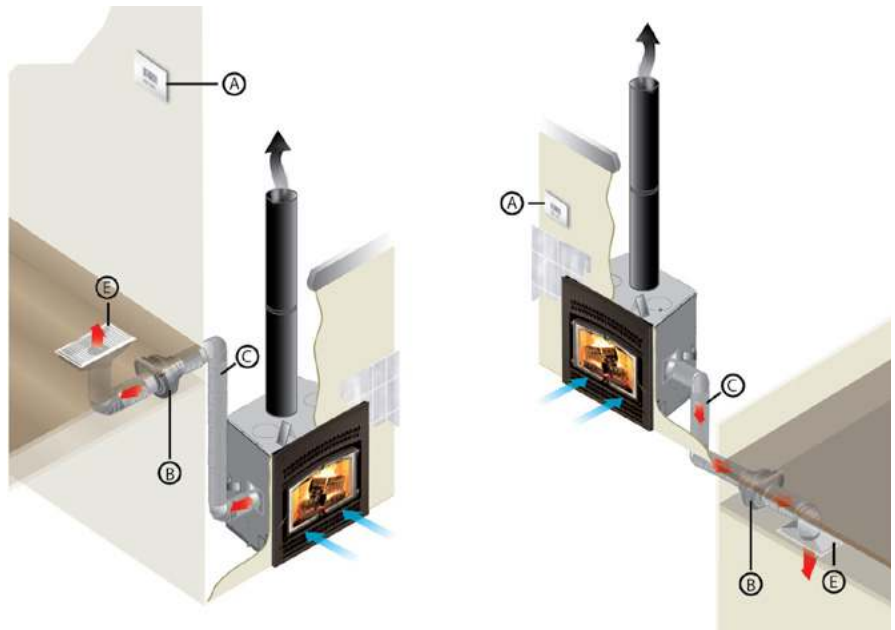

The system can also be used to supplement heat in a room remote from the fireplace. For this type of application, the thermostat needs to be positioned in the desired room and programmed with the temperature to be maintained. The system, now in "heat mode", will activate the blower as long as the temperature in the remote room is not achieved and that the fireplace has enough heat to distribute.

EPA wood fireplaces generate a lot of heat; often too much for the room where they are located. The heat distribution systems designed by Valcourt allow you to redirect this heat to other rooms in your home.

Valcourt also offers another way to distribute excess heat in your home, using a hot air gravity kit.

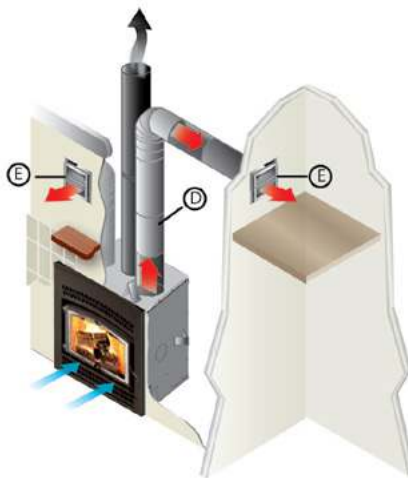

Hot air gravity kit





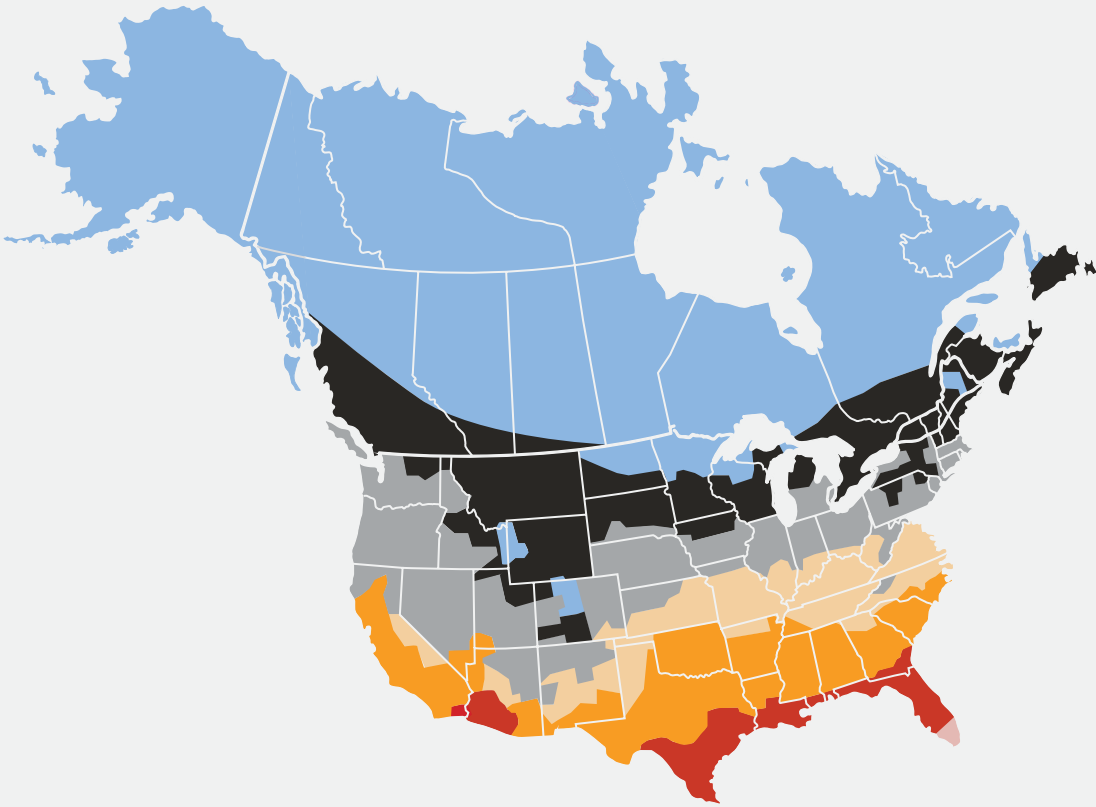

The Hot air gravity kit allows you to bring hot air into the same room as the fireplace, in adjacent rooms, or upstairs at a maximum distance of 10' (3 m). The minimum height of the hot air duct must be 68" (1.7 m) measured from the base of the fireplace to the top of the hot air register.

Suggested installation: A) Wall thermostat B) 300 CFM blower C) Hot air flexible pipe D) Hot air rigid pipe E) Air register. The information contained in this page is for information purposes only. For more details about the installation requirements of the kits and their content, please refer to the owner's manuals. For more installation options or more details on the **forced air distribution kit** or the **hot air gravity distribution kit**, visit www.valcourtinc.com/en/service-support/heat-distribution-system

Technical data contained in this catalogue are for reference only. Any installation must be done according to the data and drawings detailed in the owner's manual.

HEATING CALCULATOR



- climate**
- 7-8 
 - 6 
 - 5 
 - 4 
 - 3 
 - 2 
 - 1 

Recommended heating area
in square feet by climate zone.

	FP10R LAFAYETTE II	FP10RS LAFAYETTE II -SQUARE	FP12R MUNDO II	FP15 WATERLOO	FP15A WATERLOO - ARCHED
ZONE 1-2	3 000	3 000	3 000	3 600	3 600
ZONE 3	2 800	2 800	2 800	3 400	3 400
ZONE 4	2 600	2 600	2 600	3 200	3 200
ZONE 5	2 400	2 400	2 400	3 000	3 000
ZONE 6	2 200	2 200	2 200	2 800	2 800
ZONE 7-8	1 800	1 800	1 800	2 400	2 400



WARRANTY

Valcourt does not compromise when it comes to excellence in manufacturing its products. This is guaranteed by a highly qualified workforce and state-of-the-art equipment. This tradition of excellence allows us to offer our customers peace of mind, through one of the best warranties in the industry.

LIMITED LIFETIME

Combustion chamber (welds only)

Ceramic glass

Castings (except andirons)

Plating

For more details, visit our website at
www.valcourtinc.com/en/warranty/

ACCESSORIES

DUPLIX



AC02620

INEO



AC02621

PAPYRUS



AC02622

NORDIK



AC02628

PETALE



AC02629

FOREST



AC02630

SPEKTRA



AC02631

EQUISS



AC02350

**NON-COMBUSTIBLE MANTEL –
WASHED CEDAR**



AC02780 60"

AC02781 72"

Height: 8"
Depth: 8"

**NON-COMBUSTIBLE MANTEL –
TAVERN BROWN**



AC02782 60"

AC02783 72"

Height: 8"
Depth: 8"

STOWOOD WOOD STORAGE



AC02351

AC02353*

Height: 16"
Width: 48"
Depth: 18"

* optional drawer with shovel and poker

GLASS HEARTH PAD



AC02703 54" x 46 3/4"

AC02704 44" x 36"

AC02760 50" x 18"

AC02761 70" x 20"

Thickness: 10 mm

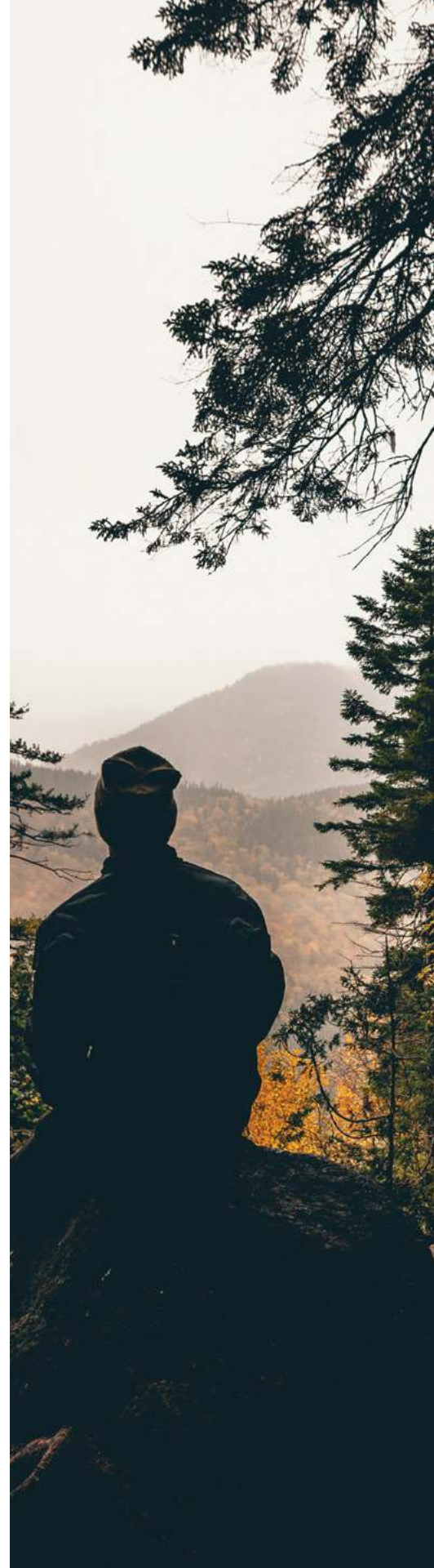

PUB066



05-2020
Printed in Canada

