

# URBANA

LUXURY FIREPLACES

## U37 / U44

USER MANUAL



**Intertek**  
C#4001609

**WARNING:** If the information in this manual is not followed exactly, a fire or explosion may result causing property damage, personal injury or loss of life. Installation and service must be performed by a qualified installer, service agency or the gas supplier.

CERTIFIED TO: ANSI Z21.50 / CSA 2.22 VENTED DECORATIVE GAS APPLIANCES  
CSA 2.17 GAS FIRED APPLIANCES FOR HIGH ALTITUDES

**C-16432**

**Retain this manual for future reference.**



**WARNING:**

**FIRE OR EXPLOSION HAZARD**

**Failure to follow safety warnings exactly could result in serious injury, death, or property damage.**

- **Do not store or use gasoline or other flammable vapours and liquids in the vicinity of this or any other appliance.**
  
- **WHAT TO DO IF YOU SMELL GAS**
  - **Do not try to light any appliance.**
  - **Do not touch any electrical switch; do not use any phone in your building.**
  - **Leave the building immediately.**
  - **Immediately call your gas supplier from a neighbor's phone. Follow the gas supplier's instructions.**
  - **If you cannot reach your gas supplier, call the fire department.**
  
- **Installation and service must be performed by a qualified installer, service agency or the gas supplier.**

This appliance is only for use with the type of gas indicated on the rating plate. This appliance is not convertible for use with other gases.

Massachusetts installations (Warning): This product must be installed by a licensed plumber or gas fitter when installed within the Commonwealth of Massachusetts. Other Massachusetts code requirements: Flexible connector must not be longer than 36in., a shut off valve must be installed; only direct vent sealed combustion products are approved for bedrooms/bathrooms. A carbon monoxide detector is required in all rooms containing gas fired direct vent appliances. The fireplace damper must be removed or welded in the open position prior to installation of a fireplace insert.

## FOR SAFE INSTALLATION AND OPERATION OF YOUR “URBANA” APPLIANCE, PLEASE CAREFULLY READ THE FOLLOWING INFORMATION:

- All Urbana gas-fired appliances must be installed in accordance with their instructions. Carefully read all the instructions in this manual first. Consult the building authority having jurisdiction to determine the need for a permit prior to commencing the installation.
- **WARNING:** Failure to follow these instructions could cause a malfunction of the fireplace, which could result in death, serious bodily injury, and/or property damage.
- Failure to follow these instructions may also void your fire insurance and/or warranty.
- Installation and repair should be done by a qualified service person. The appliance should be inspected before the first use and, at least, annually by a qualified service person. More frequent cleaning may be required due to excessive lint from carpeting, bedding material, etc. It is imperative the control compartments, burners and circulating air passageways of the appliance be kept clean.
- Due to high temperatures, the appliance should be located out of high traffic areas and away from furniture and draperies.
- Children and adults should be alerted to the hazards of high surface temperatures and should stay away to avoid burn or clothing ignition.
- Young children should be carefully supervised when in the same room as the appliance. Toddlers, young children and others may be susceptible to accidental contact burns. A physical barrier is required if there is a risk for individuals in the house. To restrict access to a fireplace or stove install an adjustable safety gate to keep toddlers, young children and other at risk individuals out of the room and away from hot surfaces. Any safety screen, guard, or barrier removed for servicing an appliance must be replaced prior to operating the appliance.
- Clothing or other flammable materials should not be placed on or near the appliance.
- A barrier designed to reduce the risk of burns from the hot viewing glass is provided with this appliance and shall be installed for the protection of children and other at-risk individuals. If the barrier becomes damaged, the barrier shall be replaced with the manufacturer’s barrier for this appliance.
- Installation and service must be performed by a qualified installer, service agency or gas supplier.
- This installation must conform to local codes or, in the absence of local codes, with the National Fuel Gas Code, ANSI Z223.1/NFPA 54, or the Natural Gas and Propane Installation Code, CSA B149.1.
- To prevent injury, do not allow anyone who is unfamiliar with the stove to operate it.
- To prevent injury, if the pilot or pilot and burners have gone out on their own, wait 5 minutes to air out before attempting to re-light the stove.
- Always keep the area around these appliances clear of combustible material, gasoline and other flammable liquids and vapours.
- These appliances should not be used as a drying rack for clothing or for hanging Christmas stockings/decorations.
- Due to the paint curing on the stove, a faint odor and slight smoking will likely be noticed when the stove is first used. Open a window until the smoking stops.
- Always connect this gas stove to a vent system and vent to the outside of the building envelope. Never vent to another room or inside the building. Make sure the specified vent pipe is used, properly sized and of adequate height to provide sufficient draft. Inspect the venting system annually for blockage and signs of deterioration.
- **WARNING:** Failure to position the parts in accordance with the diagrams in this booklet, or failure to use only parts specifically approved with this appliance, may result in property damage or personal injury.
- **WARNING:** Do not operate with the glass front removed, cracked or broken. Replacement of the glass should be done by a licensed or qualified service person.
- Never use solid fuels such as wood, paper, cardboard, coal, or any flammable liquids, etc., in this appliance.
- Do not use this appliance if any part has been under water. Immediately call a qualified service technician to inspect the appliance and to replace any part of the control system or any gas control which has been under water.
- Do not abuse the glass by striking it or slamming the door shut. If the Urbana unit is pulled out of its installation, and the vent-air intake system is disconnected for any reason, ensure that the vent-air intake pipes are reconnected and re-sealed in accordance to the instructions noted in Initial Installation - Direct Vent

## FOR YOUR SAFETY

DANGER



**HOT GLASS WILL  
CAUSE BURNS**

**DO NOT TOUCH GLASS  
UNTIL COOLED.**

**NEVER ALLOW CHILDREN  
TO TOUCH GLASS.**

A barrier designed to reduce the risk of burns from the hot viewing glass is provided with this appliance and shall be installed for the protection of children and other at-risk individuals.

**DIRECT VENT ONLY:** This type is identified by the suffix DV. This appliance draws all of its air for combustion from outside the dwelling, through a specially designed vent pipe system.

This appliance has been tested and approved for installations from 0 feet to 4500 feet (1372 m) above sea level.

**In the USA:** The appliance may be installed at higher altitudes. Please refer to your American Gas Association guidelines which state: the sea level rated input of Gas Designed Appliances installed at elevations above 2000 (610 m) feet is to be reduced 4% for each 1000 feet (305 m) above sea level. Refer also to local authorities or codes which have jurisdiction in your area regarding the de-rate guidelines.

**In Canada:** When the appliance is installed at elevations above 4500 feet (1372 m), the certified high altitude rating shall be reduced at the rate of 4% for each additional 1000 feet (305 m).

- This appliance has been tested by INTERTEK and found to comply with the established VENTED DECORATIVE GAS APPLIANCES standards in CANADA and the USA as follows:

**VENTED DECORATIVE GAS APPLIANCE ( NATURAL GAS, PROPANE GAS)**

CERTIFIED TO: ANSI Z21.50 / CSA 2.22 VENTED DECORATIVE GAS APPLIANCES

CSA 2.17 GAS FIRED APPLIANCES FOR HIGH ALTITUDES

**This Urbana Appliance:**

- Is not a source of heat.
- Has been certified for use with either natural gas or propane (see rating label).
- Is not for use with solid fuels.
- Is approved for a bedroom or bed sitting room. (**IN CANADA:** may be installed with a listed wall thermostat. **IN USA: Installation with a thermostat is not permitted,** see current ANSI Z223.1 for installation instructions.)
- Must be installed in accordance with local codes. If none exist, use current installation code CAN/CGA B149.1 in Canada or ANSI Z223.1/NFPA 54 in the USA.
- Must be properly connected to an approved venting system and not connected to a chimney flue serving a separate solid-fuel burning appliance.

**IMPORTANT NOTICE (Regarding first fire up):** When the unit is turned on for the first time, it should be turned onto high for the first 4 hours. This will cure the paint, logs, gasket material and other products used in the manufacturing process. It is advisable to open a window or door, as the unit will start to smoke and can irritate some people. After the unit has gone through the first burn, turn the unit off including the pilot, let the unit get cold then remove the glass door and clean it with a good gas fireplace glass cleaner, available at your local Urbana dealer.

NATIONAL  
FIREPLACE  
INSTITUTE



CERTIFIED

[www.nficertified.org](http://www.nficertified.org)

We recommend that our gas hearth products be installed and serviced by professionals who are certified in the U.S. by the National Fireplace Institute® (NFI) as NFI Gas Specialists.

# CONTENTS

<b>Safety Precautions</b> .....	<b>4</b>
<b>Operating Instructions</b> .....	<b>6</b>
Remote Control .....	6
Remote Control Icons .....	6
Syncing Your Remote to the Fireplace .....	7
Temperature Unit Setting.....	7
Remote Control Key lock.....	7
Low Battery Power Detection.....	7
Pilot Light Modes .....	8
Changing Pilot Light Mode .....	8
Turning On Your Fireplace .....	8
Flame Height Control .....	9
Top Light .....	9
<b>Parts Diagram</b> .....	<b>10</b>
<b>Parts List</b> .....	<b>11</b>
<b>Troubleshooting</b> .....	<b>13</b>
<b>Installation Reference Guide</b> .....	<b>14</b>
<b>Warranty Information</b> .....	<b>15</b>

### CAUTION!

**Property Damage Hazard. Excessive heat can cause property damage. The appliance can stay lit for many hours. Turn off the appliance if it is not going to be attended to .**

### ATTENTION!

**Turn "off" the main gas supply of the appliance during installation or maintenance of the IFC.**

### WARNING!

**Fire Hazard. Can cause severe injury or death. The Transmitter causes ignition of the appliance. The appliance can turn on suddenly. Keep away from the appliance burner when operating the remote system.**

### Remote Control Technical Data

Proflame 2 is a modular remote control system that directs the functions of the fireplace. The Proflame 2 remote transmitter is configured to control the on and off function of the main burner. The systems also allows you to modulate the flame level and top accent light.

### System Description:

1. Proflame 2 Transmitter
2. Integrated Fireplace Controller (IFC) and a wiring harness to connect to the gas valve and stepper motor

### Technical Data:

Transmitter (Remote Control):

- Supply voltage: 4.5 V (three 1.5 V AAA batteries)
- Radio frequency: 315 MHz

### Integrated Fireplace Controller (IFC):

- Supply voltage: AC IN - 120 V / 60 Hz
- Spark voltage / frequency: >10kV / 1Hz
- Top Light: 120 V / 60 Hz / 850mA [total]

## Remote Control

The Proflame 2 uses a streamline design, remote control to allow the user to interact with the system. The simple button layout and LCD display offers a user friendly experience. The MODE key is used to cycle through different features. The transmitter is powered by three (3) AAA type batteries.

**Note:** Other remote transmitters may interfere with the system if you have another within the vicinity.

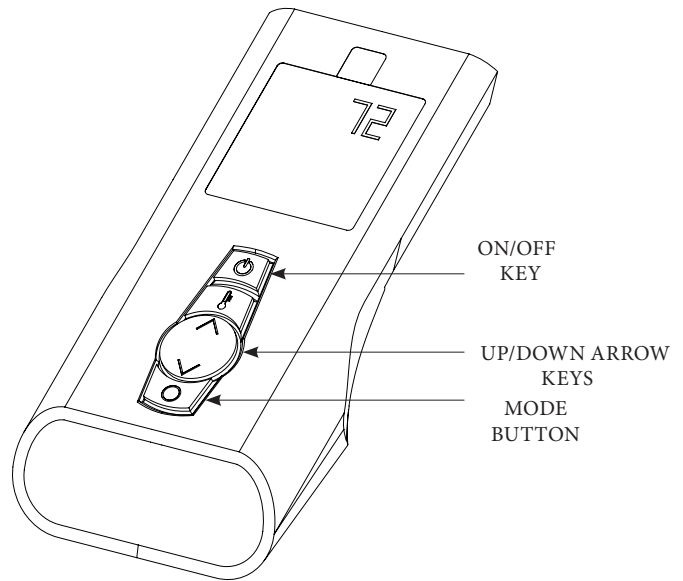

## Remote Control Icons

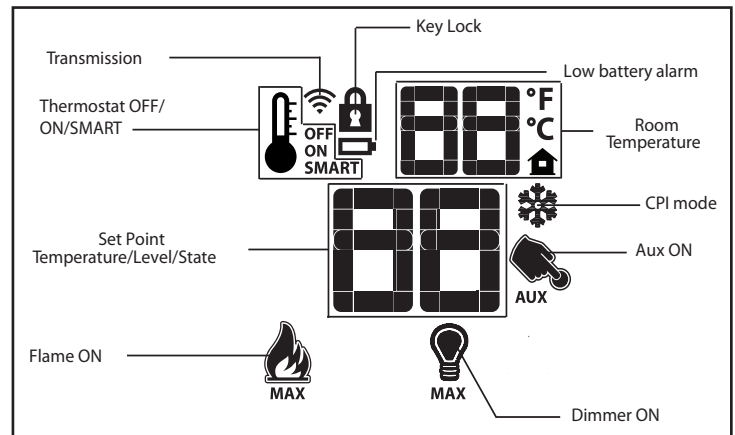

## Syncing Your Remote to the Fireplace

The remote should be synced to your fireplace by your installer during installation.

You will also need to re-sync your remote after changing the batteries

1. Each unit has a hidden switch panel on the right hand side of the fireplace opening behind a cover panel.
2. Remove the safety screen and right hand side cover panel, both are held in place with magnets.
3. Locate the switch panel and press on the middle switch; you will hear a series of 3 beeps.

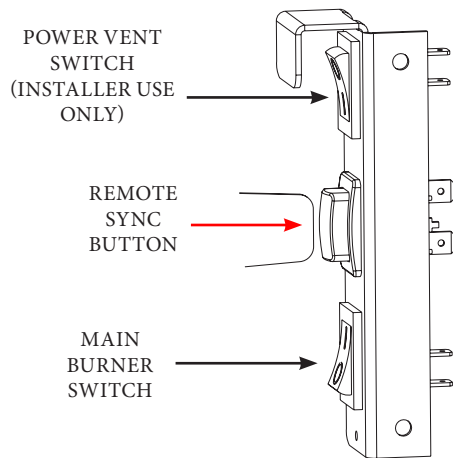

4. On hearing the 3 beeps, press the on/off key on your remote; you will hear 3 more beeps to acknowledge a successful remote syncing.

5. Press the on/off button again to turn off the remote. The remote is now ready to use.

## Temperature Unit Setting

Your remote can be set to either read °C or °F. To set your preferred unit:

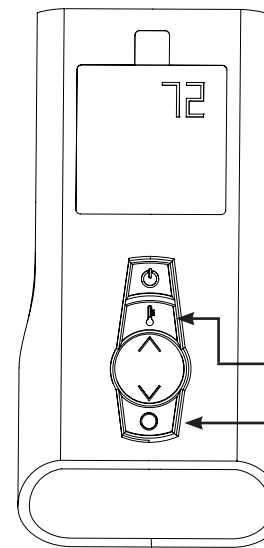

Press the Thermostat key and the Mode key simultaneously while the system is OFF.

The remote transmitter will indicate which temperature scale is being displayed (°C or °F). Repeat this sequence to change between Centigrade and Fahrenheit

## Remote Control Key lock



This function will lock the remote keys to avoid unsupervised operation.

To activate this function, press the MODE and UP keys at the same time and the a lock icon will appear.

To de-activate this function, press the MODE and UP Keys at the same time.

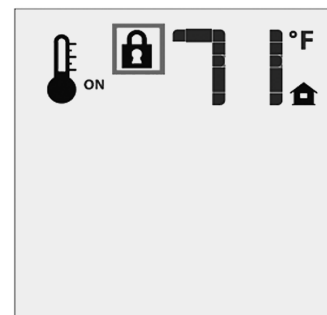

KEY LOCK

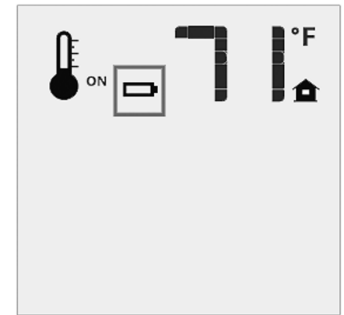

BATTERY LOW INDICATOR

## Low Battery Power Detection



The life span of the remote control batteries depends on various factors. Quality of the batteries used, the number of appliance ignitions, the number of settings changes selected, etc.

When the Transmitter batteries are low, a battery icon will appear on the LCD display of the Transmitter.

### Pilot Light Modes

Your fireplace has a pilot light which ignites the main burner.

The way in which your pilot light functions can be adjusted to your preference. The two different modes and their uses are listed below:

#### IPI - Intermittent Pilot Ignition

IPI mode only turns on when required. The pilot light remains off until you press the power key on the remote. After a few seconds, the pilot light will ignite and remain lit during the your operation of the fireplace.

This mode will use less gas, as it only uses gas when the fireplace is on.

IPI mode is often used at the end of winter when you are no longer using the fireplace regularly.

#### CPI - Continuous Pilot Mode

CPI mode keeps the pilot light ignited for 7 days. Keeping the pilot ignited, allows the firebox to remain warm. This helps the fireplace establish a draft which can be useful for days with high wind and extreme cold. Keeping the fireplace warm and thereby dry; this also helps to reduce condensation build up on the glass.

### Changing Pilot Light Mode



With the fireplace turned off, press the MODE key.

The screen will now show the current pilot mode selected use the UP and DOWN arrow keys to cycle between IPI and CPI modes.

Once the selection has been made, the fireplace will beep to acknowledge the changing of the mode.

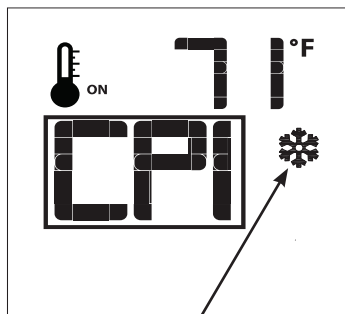
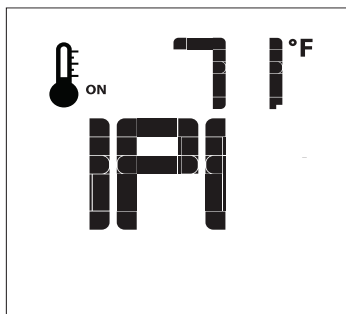

ICON CONFIRM CPI MODE SELECTION

### Turning On Your Fireplace



Press the ON/OFF Key on the remote; the LCD display will show the room temperature.

A single "beep" from the fireplace confirms reception of the command and both the pilot light (if the unit is not set to continuous pilot) and main burner will turn off.

**Note - if no beep is heard from the fireplace move closer to the unit and try again.**



## Flame Height Control



Your fireplace has 6 flame height settings. To control the height of the flame:

1. Turn on your fireplace; the flame always starts on the maximum setting "HI"
2. With your fireplace fully ignited, press the DOWN arrow key to set the desired height of your flame.

When lowering the flame height, you can turn off the fireplace with this method. The remote will read OFF when you have reached the lowest setting on the remote.

When increasing the flame height, the remote will read "Hi" when the maximum flame height is reached.



Flame Off

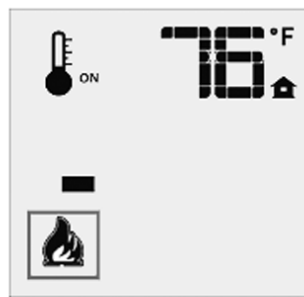

Flame Level 1

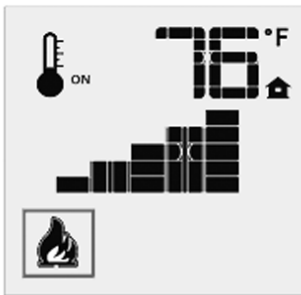

Flame Level 5

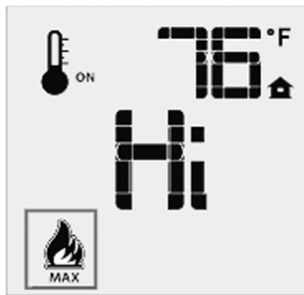

Maximum Flame Level

## Top Light

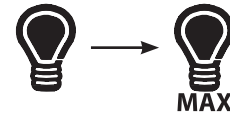

Your fireplace comes with top lights that illuminate the inside of the firebox. (All Urbana Series models come with top lights as a standard.)

To turn on your top light:

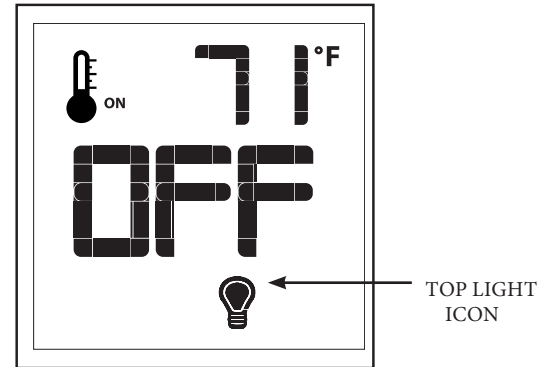

1. Turn on your fireplace.
2. Press the MODE key until the light bulb icon is visible.
3. You can control the brightness of your top light by pressing the UP and DOWN arrow keys to set your preferred brightness.

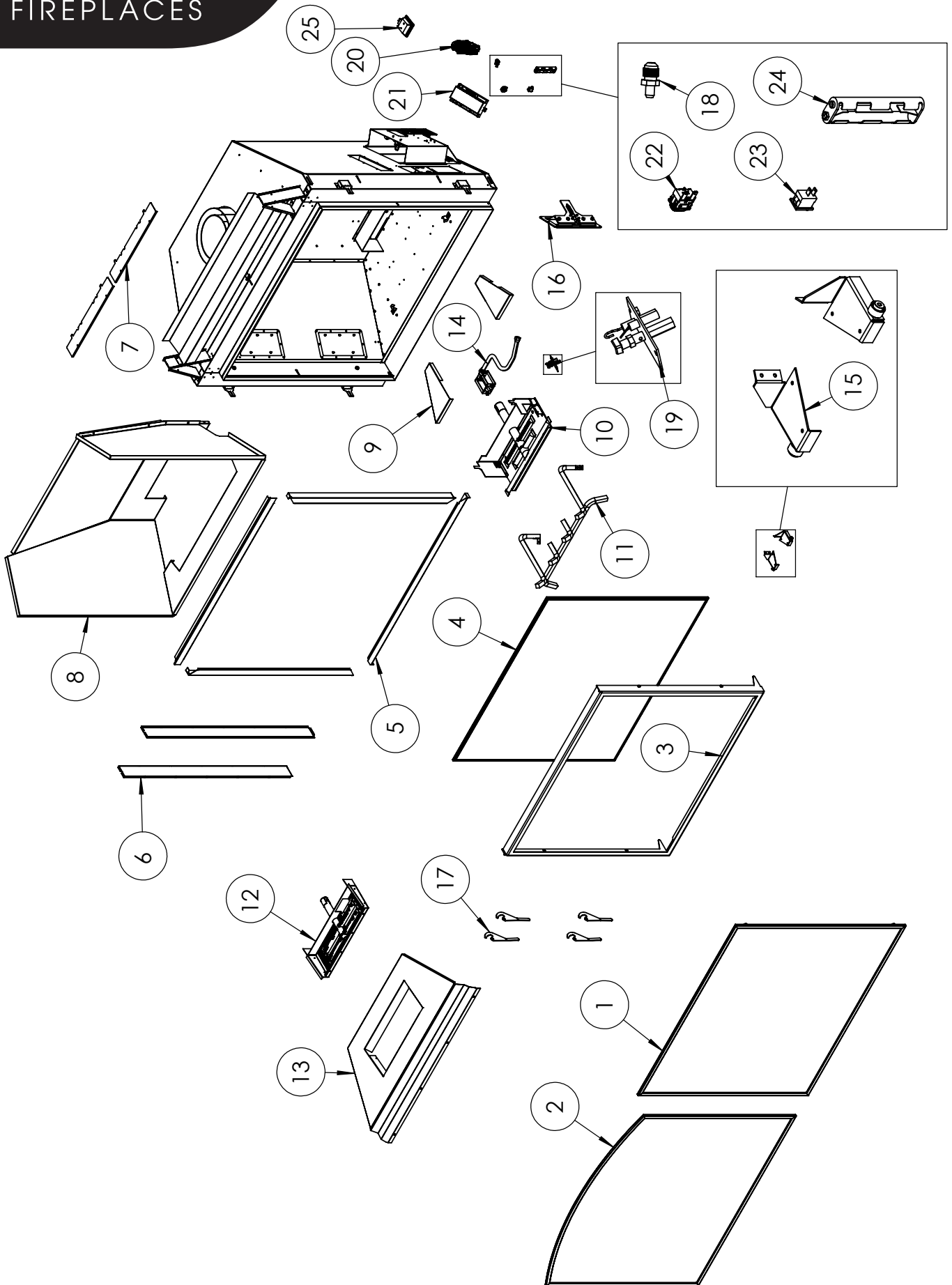

Reference Number	Part Description	Part Number
U37 Model Specific Parts		
1	Safety Screen	50-4196
2	Arched Safety Screen	50-4224
3	Firebox Door Complete	50-4197
4	Firebox Door Glass w/ Gasket	50-4198
5	Door Cover Trim Set - 4 pcs	50-4201
-	Arched Door Cover Trim Set - 4 pcs	50-4225
6	Side Cover Panel Set - 2 pcs	50-4206
7	CSS Cover Plate Set - 2 pcs	50-4207
8	Painted Steel Firebox Liner Set - 5 pcs	50-4199
9	Painted Steel Burner Accent Set - 2 pcs	50-4200
10	Log Burner Tray	50-4202
11	Log Grate	50-4203
12	Glass Burner Tray	50-4226
13	Enameled Media Tray	50-4227
14	Burner Flex Hose Assembly (no orifice)	50-4205
-	Valve Access Panel Gasket	50-4204
U44 Model Specific Parts		
1	Safety Screen	50-4208
2	Arched Safety Screen	50-4228
3	Firebox Door Complete	50-4209
4	Firebox Door Glass w/ Gasket	50-4210
5	Door Cover Trim Set - 4 pcs	50-4213
-	Arched Door Cover Trim Set - 4 pcs	50-4229
6	Side Cover Panel Set - 2 pcs	50-4218
7	CSS Cover Plate Set - 2 pcs	50-4219
8	Painted Steel Firebox Liner Set - 5 pcs	50-4211
9	Painted Steel Burner Accent Set - 2 pcs	50-4212
10	Log Burner Tray	50-4214
11	Log Grate	50-4215
12	Glass Burner Tray	50-4230
13	Enameled Media Tray	50-4231
14	Burner Flex Hose Assembly (no orifice)	50-4217
14	Burner Flex Hose Assembly (no orifice) - <i>*Glass Unit Only*</i>	50-4205
-	Valve Access Panel Gasket	50-4216

Reference Number	Part Description	Part Number
U37 / U44 Common Parts		
15	Firebox Door Roller Set - 2pcs	50-4220
16	Firebox Door Spring Relief Assembly	50-4221
17	Firebox Door Handle Set - 4pcs	50-4223
18	Valve Pressure Test Port	50-4222
19	PSE IPI Pilot Assembly (2021)	50-4058
-	IPI LP Pilot Orifice (2021)	50-4080
20	S.I.T. 885 Valve w/ NG Stepper Motor	50-2682
21	Proflame 2 IFC - Urbana	50-3887
-	Proflame 2 IFC Wire Harnes (0.584.924)	50-3030
-	IFC RF Antenna	50-4090
22	IFC Reset Button	50-3518
23	Urbana Rocker Switch	50-3892
24	Battery Holder 4 x AA	50-3027
-	Proflame 2 Transmitter (0.584.080)	50-3888
25	Top Light Assembly	50-3516
-	Top Light - Bulb Only	50-4119
-	2A Glass Fuse	50-2075
-	NG to LP Stepper Motor Only	50-3753
-	LP to NG Stepper Motor Only	50-3870
-	12 oz. Can of Matallic Black Touch Up Paint	PAINT-12-MB

<p><b>“Nothing happens when I turn on the fireplace with the remote.”</b></p>	<ol style="list-style-type: none"> <li><b>1.</b> Move closer to fireplace &amp; try again. (listen for acknowledgement beeps)</li> <li><b>2.</b> Check batteries in remote.</li> <li><b>3.</b> Re-sync the remote to the fireplace.</li> <li><b>4.</b> Check burner switch is in the on position.</li> <li><b>5.</b> Call Your dealer to arrange a service call.</li> </ol>
<p><b>“My Glass has condensation on it”</b></p>	<ol style="list-style-type: none"> <li><b>1.</b> Condensation is a normal occurrence in direct Vented fireplaces. it will evaporate when the unit heats up.</li> <li><b>2.</b> To reduce the amount of condensation you see, it is suggested to leave your unit in CPI mode. (Page 8) This leaves the pilot light on for a maximum of 7 days. This keeps your firebox warm and dry thereby reducing the moisture in the firebox that would result in condensation.</li> </ol>
<p><b>“The flames look blue”</b></p>	<ol style="list-style-type: none"> <li><b>1.</b> Blue coloured flames are a normal occurrence when the fireplace is first turned on. Venting size and setup will determine how quickly the flame establishes its orange colour.</li> <li><b>2.</b> Improper venturi or restrictor adjustment - If the flame remains blue after prolonged use contact your Urbana dealer.</li> </ol>

**Please fill in and retain this information card for your future reference.**

Go to [www.enviro.com/warranty](http://www.enviro.com/warranty) to fill in your warranty registration card.

**NAME OF DEALER:**

\_\_\_\_\_

**ADDRESS:**

\_\_\_\_\_

\_\_\_\_\_

\_\_\_\_\_

**PHONE:** \_\_\_\_\_

**NAME OF INSTALLER:**

\_\_\_\_\_

**ADDRESS:**

\_\_\_\_\_

\_\_\_\_\_

\_\_\_\_\_

**PHONE:** \_\_\_\_\_

**MODEL:** \_\_\_\_\_

**SERIAL NUMBER:** \_\_\_\_\_

**DATE OF PURCHASE:** \_\_\_\_\_ (dd/mm/yyyy)

**DATE OF INSTALLATION:** \_\_\_\_\_ (dd/mm/yyyy)

NATURAL GAS (NAT)       PROPANE(LPG)

**INLET GAS PRESSURE:** \_\_\_\_\_ in wc

**MAIN BURNER ORIFICE:** \_\_\_\_\_ # DMS

**PILOT ORIFICE #** \_\_\_\_\_ **OR** \_\_\_\_\_ in diam.

**INSTALLER'S SIGNATURE:**

\_\_\_\_\_

## URBANA LUXURY FIREPLACES

## WARRANTY INFORMATION

Sherwood Industries Ltd. ("Sherwood") hereby warrants, subject to the terms and conditions herein set forth, this product against defects in material and workmanship during the specified warranty period starting from the date of original purchase at retail. In the event of a defect of material or workmanship during the specified warranty period, Sherwood reserves the right to make repairs or to assess the replacement of a defective product at Sherwood's factory. The shipping costs are to be paid by the consumer. All warranties by Sherwood are set forth herein and no claim shall be made against Sherwood on any oral warranty or representation.

### Conditions

- ☞ A completed warranty registration must be submitted to Sherwood within 90 days of original purchase via the online warranty registration page or via the mail-in warranty registration card provided. Have the installer fill in the installation data sheet in the back of the manual for warranty and future reference.
- ☞ This warranty applies only to the original owner in the original location from date of install.
- ☞ The unit must have been properly installed by a qualified technician or installer, and must meet all local and national building code requirements.
- ☞ The warranty does not cover removal and re-installation costs.
- ☞ Sherwood Industries Ltd. reserves the right to make changes without notice.
- ☞ Sherwood Industries Ltd. and its employees or representatives will not assume any damages, either directly or indirectly caused by improper usage, operation, installation, servicing or maintenance of this appliance.
- ☞ A proof of original purchase must be provided by you or the dealer including serial number.

### Exclusions

An expanded list of exclusions is available at [www.urbanafireplaces.com/warranty.html](http://www.urbanafireplaces.com/warranty.html)

This warranty does not cover:

- ☞ Damage as a result of improper usage or abuse.
- ☞ Damage caused from over-firing due to incorrect setup or tampering.
- ☞ Damage caused by incorrect installation.

### To the Dealer

- ☞ Provide name, address and telephone number of purchaser and date of purchase.
- ☞ Provide date of purchase. Name of installer and dealer. Serial number of the appliance. Nature of complaint, defects or malfunction, description and part # of any parts replaced.
- ☞ Pictures or return of damaged or defective product may be required.

### To the Distributor

- ☞ Sign and verify that work and information are correct.

### Sherwood Industries Ltd.

6782 Oldfield Road, Victoria, BC . Canada V8M 2A3  
 Online warranty registration: [www.urbanafireplaces.com/warranty/](http://www.urbanafireplaces.com/warranty/)

Category	One Year	Two Year	Limited Lifetime (7yr)
Parts <sup>1</sup> (unit serial number required)		✓	
Firebox Liner Panels <sup>2</sup>		✓	
Firebox			✓
Burner			✓
Ceramic Logs <sup>3</sup>			✓
Ceramic Glass <sup>4</sup>	✓		
Door Assembly			✓
Exterior Panels (excluding finish) <sup>5</sup>			Up to 5 years
Electrical Components		✓	
Labour	✓		

<sup>1</sup> Whereas warranty has expired, replacement parts will be warranted for 90 days from part purchase date. Labour not included. Unit serial # required.

<sup>2</sup> Excluding damage to the finish caused by improper setup of the appliance, or color changes.

<sup>3</sup> Log set and panels excludes wear and tear or breakage caused by cleaning or service.

<sup>4</sup> Glass is covered for thermal breakage. Photos of box, inside of door, and unit serial # must be supplied for breakage due to shipping.

<sup>5</sup> Exterior Surface finishing covers plating, enamel or paint and excludes colour changes, chipping, and fingerprints. Travel costs not included.